

# NOMAD STRIP<sup>03</sup>

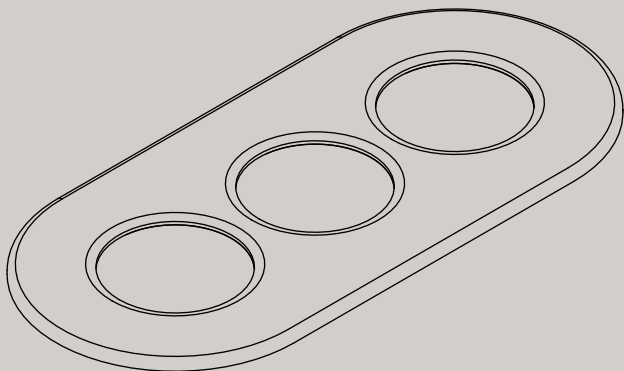

PARTS

---

(A) ×1 PCE



(B) ×2 PCS



(C) ×4 PCS



(D) ×2 PCS



TOOLS (NOT INCLUDED)

---

T1 ×1 PCE



OR T2 ×1 PCE 73mm

+

T3 ×1 PCE



T4 ×1 PCE 3mm



**GENERAL NOTES**

BEFORE INSTALLATION, ALL MEASUREMENTS AND CONDITIONS MUST BE VERIFIED ON SITE. NEITHER FORMING FUNCTION NOR ANY OF ITS DISTRIBUTORS CAN BE HELD LIABLE FOR PRODUCT MALFUNCTION OR OTHER DEFECTS AS A RESULT OF IMPROPER INSTALLATION.

**GENERAL NOTES**

AVANT L'INSTALLATION, TOUTES LES DIMENSIONS ET CONDITIONS DOIVENT ÊTRE VÉRIFIÉES SUR PLACE. NI FORMING FUNCTION NI SES PARTENAIRES COMMERCIAUX NE PEUVENT ÊTRE TENUS RESPONSABLES DES DÉFAUTS DU PRODUIT OU D'AUTRES DÉFAUTS POUVANT ÊTRE ATTRIBUÉS À UNE MAUVAISE INSTALLATION.

**GENERAL NOTES**

VOR DEM EINBAU SIND ALLE MASSE UND BEDINGUNGEN BAUSEITS ZU PRÜFEN. WEDER FORMING FUNCTION NOCH SEINE VERTRIEBSPARTNER KÖNNEN FÜR PRODUKTFEHLER ODER SONSTIGE MÄNGEL, DIE AUF UNSACHGEMASSE INSTALLATION ZURÜCKZUFÜHREN SIND, HAFTBAR GEMACHT WERDEN

**HOLE DIMENTIONS**

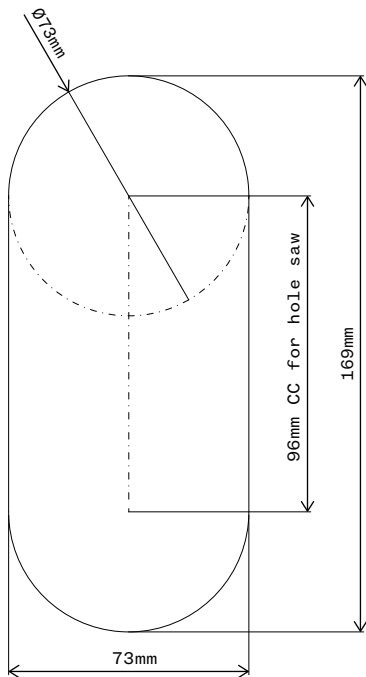

(NOT TO SCALE)

**STEP 1**

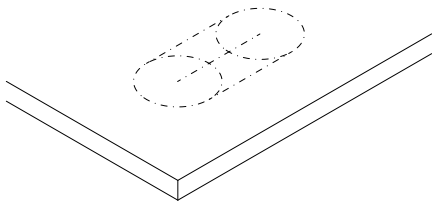

---

**STEP 2**

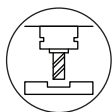

T1

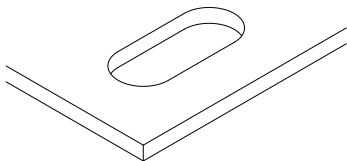

OR

**1**



T2

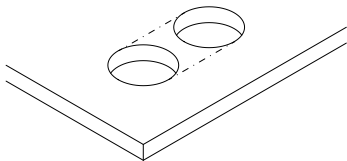

**2**



T3

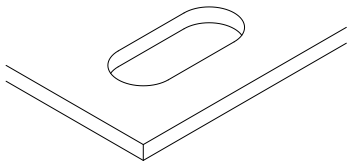

---

**STEP 3**

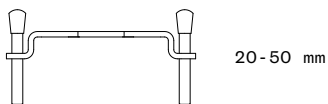
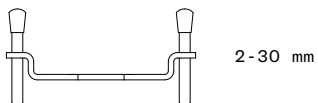
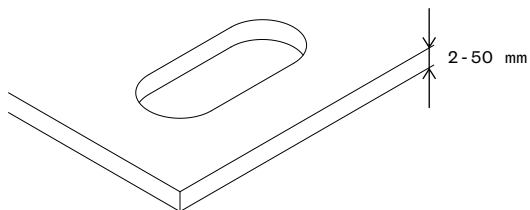

---

**STEP 4**

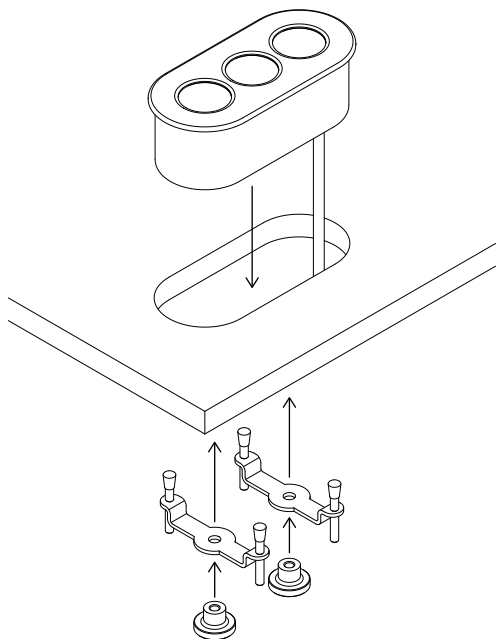



---

**STEP 5**

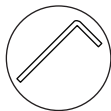
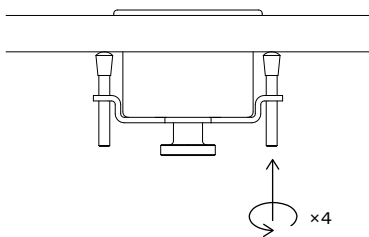

---

**STEP 6**

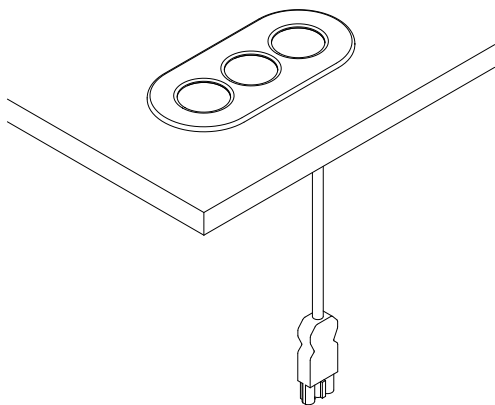

L